

Signal Tower Ø 35 mm BR 35



- modular design with six different colour elements and four mounting methods offers endless combination possibilities
- high protection system
- the light is amplified by the internal prisms of the impact-proof, heat-resistant and dustproof polycarbonate lens and can be easily identified from all sides
- appealing design with a diameter of just 35 mm
- the BR 35 signal tower is the attractive icing on the cake for machine and production lines
- for use in electronic production, in laboratories, in medical technology and in all other indoor applications
- the technically and economically optimum solution for every application
- registered design no. Nr. 9706583.8, utility patent no. 29716867.3

IP 54

Protection system

+ 55 °C
- 35 °C

LED

+ 45 °C
- 35 °C

Filament lamp

Electrical data	BR 35			
Rated voltage	230 V AC	115 V AC	24 V DC	12 V DC
Rated frequency	50 Hz / 60 Hz	50 Hz / 60 Hz		
Operating range	- 15% / + 10%	- 15% / + 10%	- 15% / + 20%	- 15% / + 20%
Capacity of light source	3 W	3 W	4 W	4 W

Mechanical data	BR 35	
Light source	AC	BA9s, 3 W (previously installed)
	DC	BA9s, max. 4 W (previously installed)
Number of modules	max. 4	
Lens colours	clear, yellow, amber, red, green, blue	
Sound pressure level, sounder module	75 dB (A)	
Operating temperature	LED	- 35 °C ... + 55 °C
	filament lamp	- 35 °C ... + 45 °C
Storage temperature	- 45 °C ... + 70 °C	
Relative humidity	90%	
Protection system according to EN 60529	IP 54	
Duty cycle	100%	
Service life of light source	approx. 1,000 hrs	
Material	housing	acrylonitrile butadiene styrene (ABS)
	lens	polycarbonate (PC)
	tube	stainless steel
Type of connection	cable length 0.5 m tube mounting; 0.65 panel mounting	
Terminal cross-section	single wire: 1.5 mm ² , fine wire: 0.14 – 1.5 mm ²	
Mounting information	just one screw is sufficient for exchanging beacon filters or light source	
Mounting methods	mounting stand, plinth mounting, tube mounting, panel mounting (see drawings on page 188)	



Maahantuonti ja myynti: Autrosafe Oy, puh. (09) 270 90 120, www.autrosafe.fi

Dimensions

Stand mounting

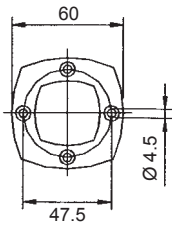
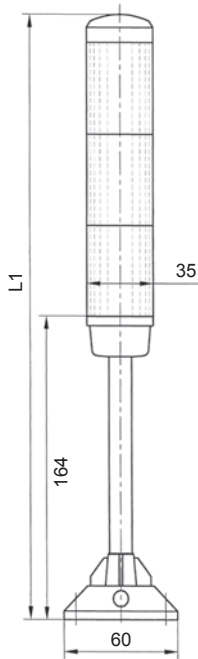

Plinth mounting

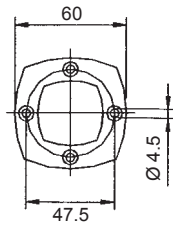
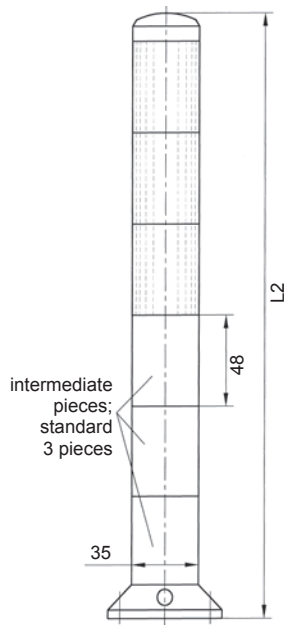

Tube mounting

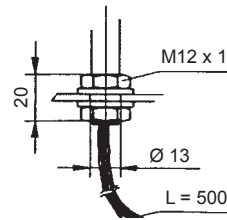
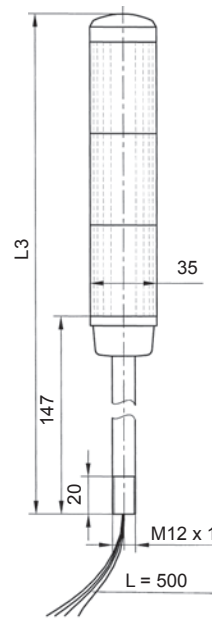

Panel mounting

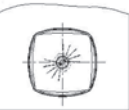
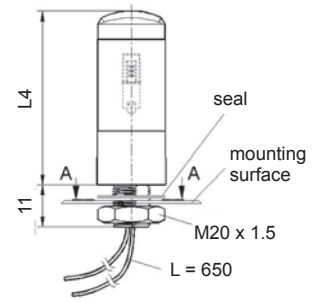

Panel cut-out

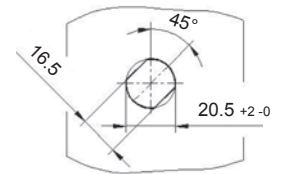

	L1	L2	L3	L4
1-stage	228	228	210	91
2-stage	276	276	258	142
3-stage	324	324	306	190
4-stage	372	372	354	238
5-stage	420	420	402	286

Connection diagrams

Stand mounting

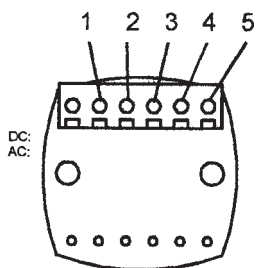

Plinth mounting

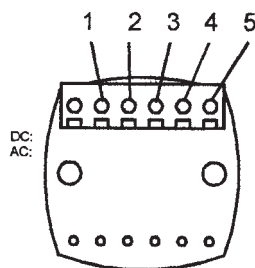

Tube mounting / Panel mounting

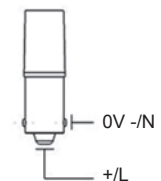
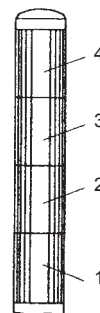

Wire no.	Light segment
1	1
2	2
3	3
4	4
N	-/N

Ordering details			
Article numbers		BR 35 mounting stand	
Version	Rated voltage	230 V AC	24 V DC
1-stage BR 35-1-S		220 80 10 1 000	220 80 80 1 000
2-stage BR 35-2-S		220 80 10 2 000	220 80 80 2 000
3-stage BR 35-3-S		220 80 10 3 000	220 80 80 3 000
4-stage BR 35-4-S		220 80 10 4 000	220 80 80 4 000
3-stage with fixed colour order: top: red, middle: yellow, bottom: green		220 80 10 0 000	220 80 80 0 000
Article numbers		BR 35 plinth mounting	
Version	Rated voltage	230 V AC	24 V DC
1-stage BR 35-1-P		220 81 10 1 000	220 81 80 1 000
2-stage BR 35-2-P		220 81 10 2 000	220 81 80 2 000
3-stage BR 35-3-P		220 81 10 3 000	220 81 80 3 000
4-stage BR 35-4-P		220 81 10 4 000	220 81 80 4 000
Article numbers		BR 35 tube mounting	
Version	Rated voltage	230 V AC	24 V DC
1-stage BR 35-1-T		220 82 10 1 000	220 82 80 1 000
2-stage BR 35-2-T		220 82 10 2 000	220 82 80 2 000
3-stage BR 35-3-T		220 82 10 3 000	220 82 80 3 000
4-stage BR 35-4-T		220 82 10 4 000	220 82 80 4 000
Article numbers		BR 35 panel mounting	
Version	Rated voltage	230 V AC	24 V DC
1-stage BR 35-1-PM		220 83 10 1 000	220 83 80 1 000
2-stage BR 35-2-PM		220 83 10 2 000	220 83 80 2 000
3-stage BR 35-3-PM		220 83 10 3 000	220 83 80 3 000
4-stage BR 35-4-PM		220 83 10 4 000	220 83 80 4 000

Article numbers for other voltages on request

Options / Accessories



for stand-
or plinth
mounting
(plastic)

Article number:
282 35 20 0 020



for tube
mounting
(metal)

Article number:
282 35 20 0 010



sounder
module

Article number:
282 35 80 8 000



plinth-moun-
ted device
with short foot



Light source



GOST

See page 191 for further information

Ordering examples

Stand mounting	Plinth mounting	Tube mounting	Panel mounting
<p>3-stage BR 35 with mounting stand 24 V DC, colour order: A = red B = yellow C = green</p> <p>Article number: 220 80 80 3 000</p>	<p>3-stage BR 35 with plinth mounting 230 V AC, colour order: A = red B = yellow C = green</p> <p>Article number: 220 81 10 3 000</p>	<p>3-stage BR 35 with tube mounting 24 V DC, colour order: A = yellow B = clear C = green</p> <p>Article number: 220 82 80 3 000</p>	<p>1-stage BR 35 for panel mounting 230 V AC, colour order: A = red</p> <p>Article number: 220 83 10 1 000</p>

Please indicate color sequence (A/B/C/D) in your order as depicted above.